

# Neurology<sup>®</sup>

## **Hereditary endotheliopathy with retinopathy, nephropathy, and stroke (HERNS)**

J. Jen, A. H. Cohen, Q. Yue, et al.  
*Neurology* 1997;49:1322-1330  
DOI 10.1212/WNL.49.5.1322

**This information is current as of November 1, 1997**

The online version of this article, along with updated information and services, is located on the World Wide Web at:

<http://www.neurology.org/content/49/5/1322.full.html>

*Neurology*® is the official journal of the American Academy of Neurology. Published continuously since 1951, it is now a weekly with 48 issues per year. Copyright . All rights reserved. Print ISSN: 0028-3878. Online ISSN: 1526-632X.



- aphasia during left-hemisphere anesthesia. *Neurology* 1995; 45:65–67.
22. Buchtel HA, Henry TR, Abou-Khalil B. Memory for neurological deficits during the intracarotid amytal procedure: a hemispheric difference. *J Clin Exp Neuropsychol* 1992;14:96–97.
23. Kaplan RF, Meadows ME, Cohen RA, Bromfield EB, Ehrenberg BL. Awareness of deficit after the sodium amobarbital (Wada) test [abstract]. *J Clin Exp Neuropsychol* 1993;15:383.
24. Durkin MW, Meador KJ, Nichols ME, Lee GP, Loring DW. Anosognosia and the intracarotid amobarbital procedure (Wada test). *Neurology* 1994;44:978–979.
25. Carpenter K, Berti A, Oxbury S, Molyneux AJ, Bisiach E, Oxbury JM. Awareness of and memory for arm weakness during intracarotid sodium amytal testing. *Brain* 1995;118: 243–251.
26. Myers JL, DiCecco JV, White JB, Borden VM. Repeated measurements on dichotomous variables: Q and F tests. *Psychol Bull* 1982;92:517–525.

---

## Hereditary endotheliopathy with retinopathy, nephropathy, and stroke (HERNS)

J. Jen, MD, PhD; A.H. Cohen, MD; Q. Yue, MD; J.T. Stout, MD, PhD; H.V. Vinters, MD; S. Nelson, MD; and R.W. Baloh, MD

---

**Article abstract**—We describe a Chinese American family with a hereditary syndrome consisting of retinopathy, nephropathy, and stroke, affecting 11 members spanning three generations. Ophthalmologic evaluations revealed macular edema with capillary dropout and perifoveal microangiopathic telangiectases. Several members had renal abnormalities with proteinuria and hematuria. Initial manifestations were visual impairment and renal dysfunction; neurologic deficits occurred in the third or fourth decade of life. Symptoms included migraine-like headache, psychiatric disturbance, dysarthria, hemiparesis, and apraxia. Neuroimaging consistently demonstrated contrast-enhancing subcortical lesions with surrounding edema. Ultrastructural studies showed distinctive multilaminated vascular basement membranes in the brain and in other tissues, including the kidney, stomach, appendix, omentum, and skin. Genetic analysis ruled out linkage to the CADASIL locus on chromosome 19. Distinct from CADASIL, hereditary endotheliopathy with retinopathy, nephropathy, and stroke (HERNS) is an autosomal dominant multi-infarct syndrome with systemic involvement.

NEUROLOGY 1997;49:1322–1330

---

Multi-infarct syndrome is characterized clinically by progressive neuropsychiatric deterioration and radiographically by multiple subcortical white matter lesions. It is generally sporadic, associated with aging and hypertension; occasionally, it can be inherited. The mechanism underlying multifocal white matter disease is not well understood. Elucidating the pathophysiology in familial multi-infarct syndromes may shed light on mechanisms of white matter injury in general.

In 1977, Sourander and Wälinder<sup>1</sup> reported a family with hereditary progressive leukoencephalopathy in middle-aged adults without hypertension. That family is probably the first reported case of cerebral autosomal dominant arteriopathy with subcortical infarcts and leukoencephalopathy (CADASIL), an autosomal dominant syndrome mapped to chromosome 19<sup>2</sup> and recently found to result from mutations

in the human *Notch3* gene.<sup>3</sup> How these mutations lead to the vasculopathy is unknown. In 1988, Grand et al.<sup>4</sup> reported a large family with clinical features similar to CADASIL; in addition, family members developed visual loss due to characteristic retinal capillary abnormalities. Gutmann et al.<sup>5</sup> later described another family with a similar syndrome of progressive visual loss and leukoencephalopathy without any renal or other organ involvement.

We report on a Chinese family, with 11 affected members spanning three generations, who manifested a hereditary vasculopathy similar to cerebrotinal vasculopathy,<sup>4,5</sup> with subcortical leukoencephalopathy and retinopathy, as well as renal dysfunction. Genetic analysis ruled out linkage to the CADASIL locus on 19p. Ultrastructural studies identified characteristic alterations of vascular basement membranes not previously described.

From the Departments of Neurology (Drs. Jen, Yue, and Baloh), Pathology and Laboratory Medicine (Drs. Cohen and Vinters), Medicine (Dr. Cohen), Pediatrics (Dr. Nelson), and Surgery (Dr. Baloh), UCLA School of Medicine; Department of Pathology (Dr. Cohen), Cedars-Sinai Medical Center; and Departments of Ophthalmology and Cell and Neurobiology (Dr. Stout), USC School of Medicine, Los Angeles, CA.

Supported by NIH grants AG9063, DC02952, DC00008-20 and PHS P30AG10123, P01AG12435.

Received April 7, 1997. Accepted in final form June 17, 1997.

Address correspondence and reprint requests to Dr. R.W. Baloh, Department of Neurology, UCLA School of Medicine, Box 951769, 710 Westwood Plaza, Los Angeles, CA 90095-1769.

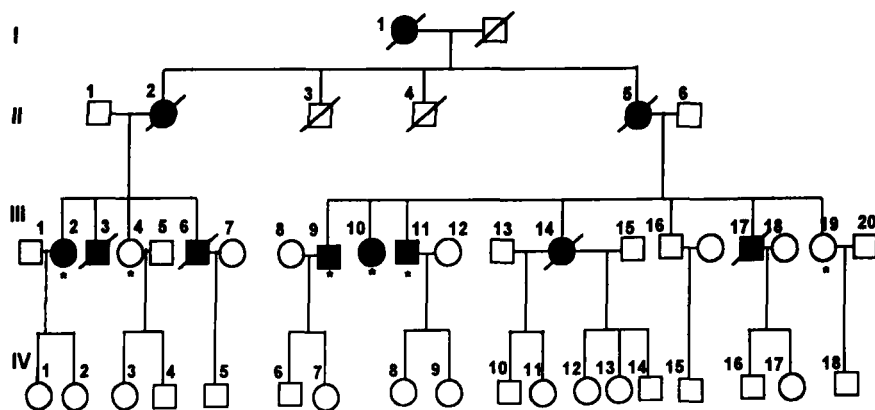

Figure 1. Pedigree shows an autosomal dominant pattern of inheritance spanning three generations. Closed figures indicate subjects were affected; asterisks indicate subjects were examined.

**Case reports.** Clinical history was obtained from patient interviews. Six members from this kindred were examined. Medical records of these members as well as those deceased (III-3, III-6, III-14, III-17) were reviewed. The pedigree is shown in figure 1. Table 1 summarizes the clinical features of affected members.

**Patient 1 (pedigree III-3).** This ambidextrous man was 28 when he first noted blind spots in his visual field. He had retinal vasculopathy of unclear etiology and underwent laser treatment. At age 32, while working as an artist painting portraits for royalty in Saudi Arabia, the patient noted the sudden onset of right-hand weakness, which rapidly progressed to involve his right leg. Head CT showed a 2-cm ring-enhancing deep white matter lesion in the left frontoparietal region with surrounding edema. Corticosteroids provided some clinical improvement. He underwent subtotal excision of the left frontal lesion, a presumed malignancy. After a follow-up scan showed progression of the lesion, he underwent a second biopsy. Postoperatively, the patient became discouraged and depressed, then committed suicide. Detailed information regarding his renal function was not available except that he had 2+ proteinuria, with urea nitrogen of 19 mg/dL and creatinine of 1.4 mg/dL. An autopsy was not performed.

**Patient 2 (pedigree III-11).** A 45-year-old right-handed man with a long-standing history of anxiety presented at

age 42 complaining of insidious onset of stuttering speech. At age 32, he had noted blind spots in his visual field, but had no focal neurologic deficits. Ophthalmologic evaluation at that time revealed focal areas of macular edema associated with capillary telangiectasis (figure 2). Focal laser photocoagulation was applied to these areas, and the edema largely resolved. Over the course of the next 5 years, additional areas of macular edema evolved and spontaneously resolved without further photocoagulation.

Brain MRI showed no focal lesion (figure 3A). At the time of initial presentation with neurologic complaints, the then 42-year-old patient exhibited only verbal stuttering, diffuse hyperreflexia, and severe anxiety, with an otherwise normal neurologic examination. Serum and CSF examinations were all normal. Brain MRI demonstrated multiple high T2 signal intensity (figure 3B) and gadolinium-enhancing lesions in the paraventricular white matter and corpus callosum (figure 3C). A brief course of corticosteroid treatment was of no benefit. The patient subsequently developed progressive limb paresis, apraxia, and dementia. Follow-up brain MRI a year later showed progression of the subcortical lesions that had become confluent (figure 3D). Serum creatinine level was 1.7 mg/dL, with trace albuminuria and hematuria (5 RBC/HPF). The patient was bedridden and demented by age forty-four.

**Patient 3 (pedigree III-2).** A 36-year-old, right-handed woman first noted blind spots in her visual field with un-

Table 1 Clinical features of affected family members

Family member	Sex	Age at onset of neurologic deficits (y)	Age at death (y)	Migraine headache	Retinopathy	Stroke-like episodes and dementia	Psychiatric disturbance	Renal insufficiency and proteinuria	Subcortical lesions on CT/MRI
I-1	F	50	60	+	+	+	-	Unknown	Unknown
II-2	F	39	44	+	+	+	-	Unknown	+
II-5	F	43	52	+	+	+	-	Unknown	Unknown
III-2	F	31	35	+	+	+	-	+	+
III-3	M	32	32	Unknown	+	+	+	-	+
III-6	M	36		+	+	+	-	-	+
III-9	M	-		+	+	-	-	+	+
III-10	F	40		Unknown	+	+	+	-	+
III-11	M	42		-	+	+	+	-	+
III-14	F	39	44	Unknown	+	+	Unknown	-	+
III-17	M	40s	51	+	+	+	+	+	Unknown

F = female; M = male; + = symptom was experienced by patient; - = symptom was not experienced by patient.

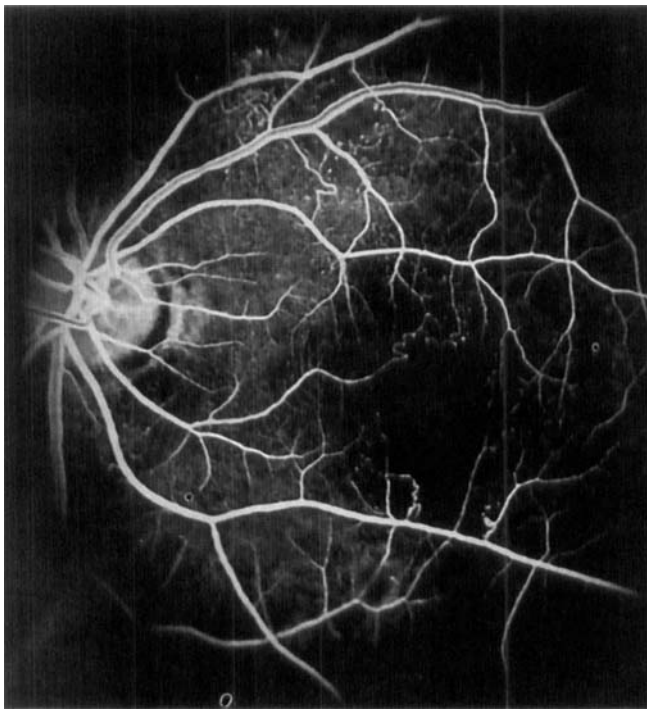

Figure 2. Mid-venous phase fluorescein angiogram from patient III-11 demonstrating areas of macular capillary dropout as well as dilated tortuous telangiectatic vessels and capillary shunts.

impaired visual acuity at age thirty-one. Having cared for her mother and her two brothers when they fell ill, the patient anticipated neurologic deterioration to follow the onset of scotomata. With the development of blind spots, the patient experienced onset of frequent right-sided headaches that were occasionally preceded by visual aura. Though neurologically asymptomatic at the time, she underwent a brain MRI, which revealed no focal lesions. At age 34, still neurologically normal, she had a repeat brain MRI which showed multiple small high-intensity signals bilaterally on T2-weighted images (figure 4A).

At age 36, she noticed slight clumsiness in her left hand while typing. Within a week, the weakness had progressed to involve her left leg. A brain MRI showed two subcortical contrast-enhancing lesions with surrounding edema in the right frontoparietal region (figure 4B).

A month after the onset of left hemiparesis, she developed blurred vision and a persistent pressure-like headache that was worse while lying down, mostly involving her right eye and the right side of her head. One night she had projectile vomiting without nausea. She remained awake, alert, ambulatory, with reactive pupils but slightly blurred disk margins. Brain MRI showed increased size of the lesions with pronounced vasogenic edema and impending herniation (figure 4C). She was admitted to the intensive care unit and treated with high doses of corticosteroids. Within a few days, much of the edema had resolved (figure 4D). Corticosteroids were slowly tapered, and she remained neurologically unchanged.

At the time of the diagnosis of retinal vasculopathy at age 31, she had renal insufficiency manifested by elevated serum creatinine to 2.5 mg/dL, proteinuria (300 mg/dL), and hematuria (15 to 20 RBC/HPF).

**Methods.** *Ophthalmologic examination.* Fluorescein angiography was performed in five patients (III-2, III-3, III-9, III-10, III-11) using standard procedures involving the injection of 5 mL of aqueous fluorescein dye in the antecubital vein followed by serial photographs over 20 minutes.

*Neuroimaging studies.* Brain CTs from three deceased patients (III-3, III-6, III-14) were reviewed. Brain MRI (T1- and T2-weighted axial sections with contrast) was carried out in six patients (III-2, III-4, III-9, III-10, III-11, III-19).

*Histologic studies.* Formalin-fixed, paraffin-embedded sections from two (III-3, III-14) patients' brain biopsies were obtained from Taiwan and studied by light microscopy. The specimens were reprocessed for electron microscopy.<sup>6</sup> Kidney biopsy specimen was obtained from patient III-2 to evaluate the nature of renal dysfunction. The renal specimen was processed in the standard manner for light microscopy, electron microscopy, and immunofluorescence.<sup>7</sup> The patient later underwent appendectomy for abdominal discomfort; her intestinal tissue was paraffin-embedded for light microscopy and later reprocessed for electron microscopy, as above. A skin biopsy specimen for light and electron microscopy was obtained from the same patient to investigate possible systemic involvement. Gastric tissue from patient III-9 became available for light and electron microscopic examination when he had elective endoscopy with biopsy.

*Genetic studies.* For genetic linkage analysis, after obtaining informed consent of family members, we isolated DNA from peripheral blood<sup>8</sup> and typed a series of microsatellite markers on chromosome 19p<sup>9</sup> with the following loci: D19S413-5cM-D19S221-6cM-D19S226-1cM-D19S841/D19S253.<sup>10</sup> We used the MLINK option in FASTLINK<sup>11</sup> for two-point linkage analysis, assuming autosomal dominant inheritance of a rare gene (population frequency 0.0001).

**Results.** *Clinical data.* This large kindred of Chinese descent has 11 affected individuals spanning three generations (see figure 1 and table 1). Progressive visual loss typically began in the third and fourth decades of life in affected individuals, followed by focal neurologic deficits within 4 to 10 years. Many affected individuals had longstanding psychiatric symptoms (depression, anxiety, paranoia) with onset in the late second decade of life. Migraine was common (I-1, II-2, III-2, III-6, III-3). Signs of multifocal cortical and subcortical dysfunction such as dysarthria, hemiparesis, apraxia, ataxia, and dementia were also common. In addition, several members had renal dysfunction (III-2, III-9, III-11), with azotemia, proteinuria, or hematuria; none required dialysis.

*Fluorescein angiography.* Fluorescein angiograms showed juxtafoveal capillary obliteration with tortuous telangiectatic microaneurysms in all five affected members who were examined (see figure 2).

*Neuroimaging.* Three patients (III-2, III-9, III-10) with initial retinal involvement had multifocal T2 high signal intensity lesions in the deep white matter on MRI before neurologic symptoms and signs developed. With the onset of focal neurologic deficits, the patients had contrast-enhancing lesions with surrounding vasogenic edema, most commonly in the deep frontoparietal regions.

*Histopathology.* Brain biopsy from patient III-3 disclosed several abnormalities. Many fragments showed fea-

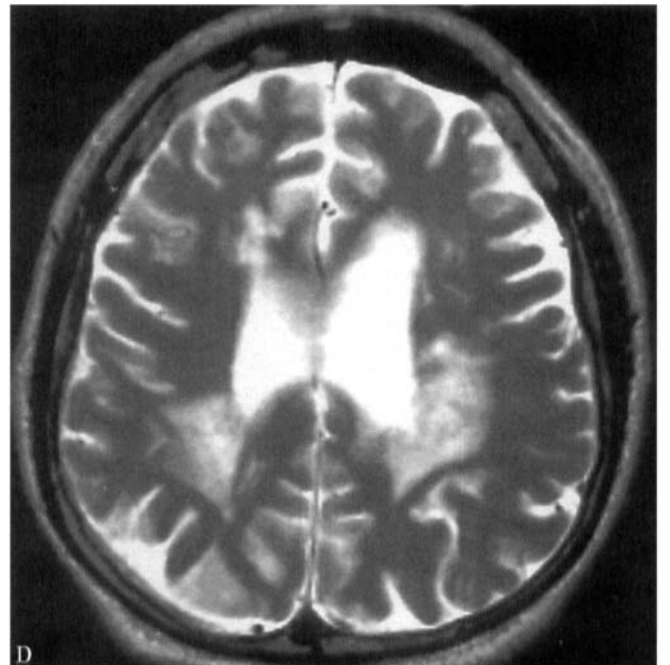
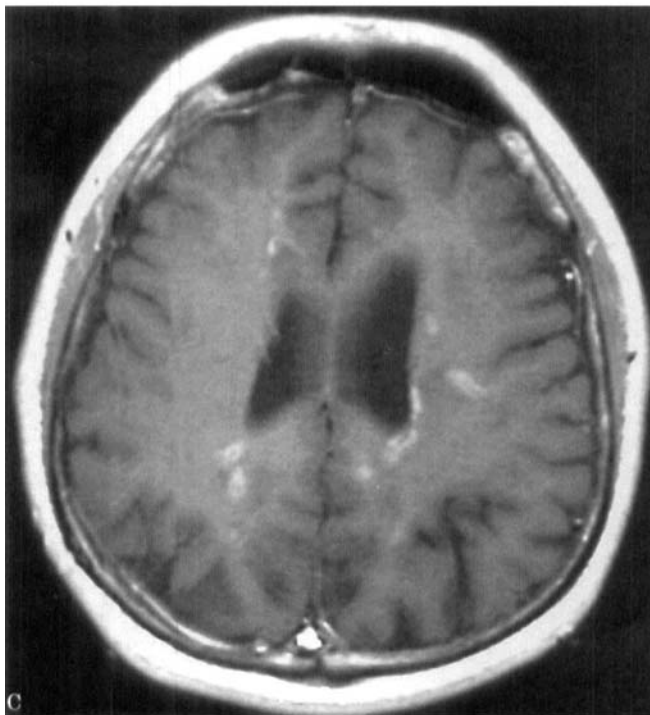
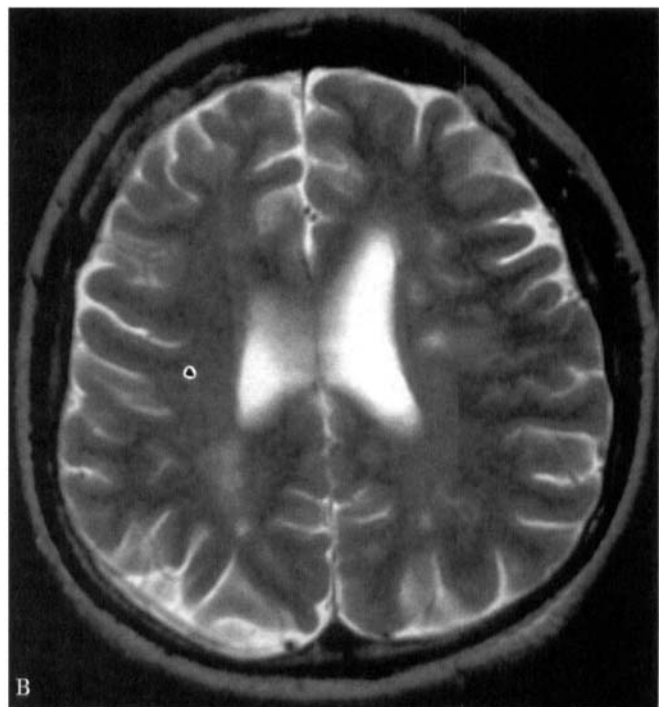
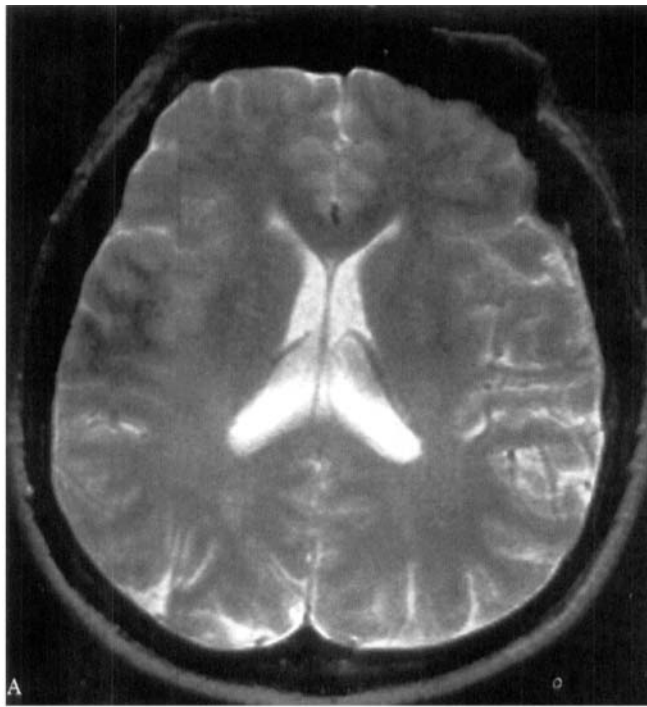

*Figure 3. Brain MRIs of patient III-11. (A) Visual complaints at age 32 but prior to the development of focal neurologic abnormalities, no focal lesion on T2-weighted images. (B) Dysarthria, hyperreflexia, and severe anxiety at age 42, multiple hyperintense T2-weighted lesions in the paraventricular white matter and the corpus callosum. (C) The lesions in panel B enhance after gadolinium injection on T1-weighted images. (D) Within a year, multifocal subcortical lesions coalesce to form large confluent areas of abnormal T2-weighted signal intensity.*

tures of a subacute cerebral infarct, with extensive nuclear fragmentation and spongy change, often centered on small blood vessels occluded by fibrin thrombi. Neurons were surrounded by significant edema. No inflammation was observed in the leptomeninges. No senile plaques, neurofibrillary tangles, or cerebral amyloid angiopathy were iden-

tified. There was no evidence of a neoplasm or a vasculitis. There was intense subpial and subcortical white matter astrocytic gliosis. Material from available tissue blocks reprocessed for electron microscopy was suboptimal for detailed evaluation; however, multilayered appearance to the capillary basement membrane was noted (figure 5A).

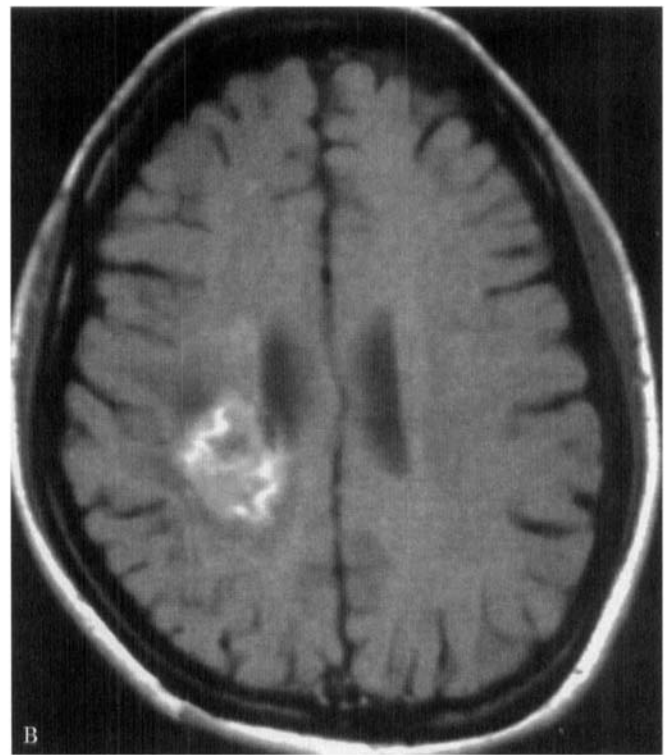
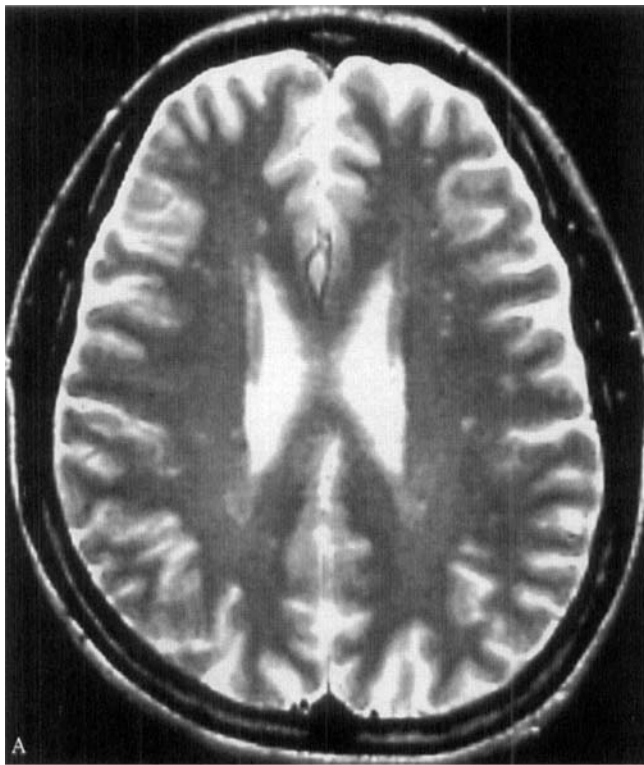
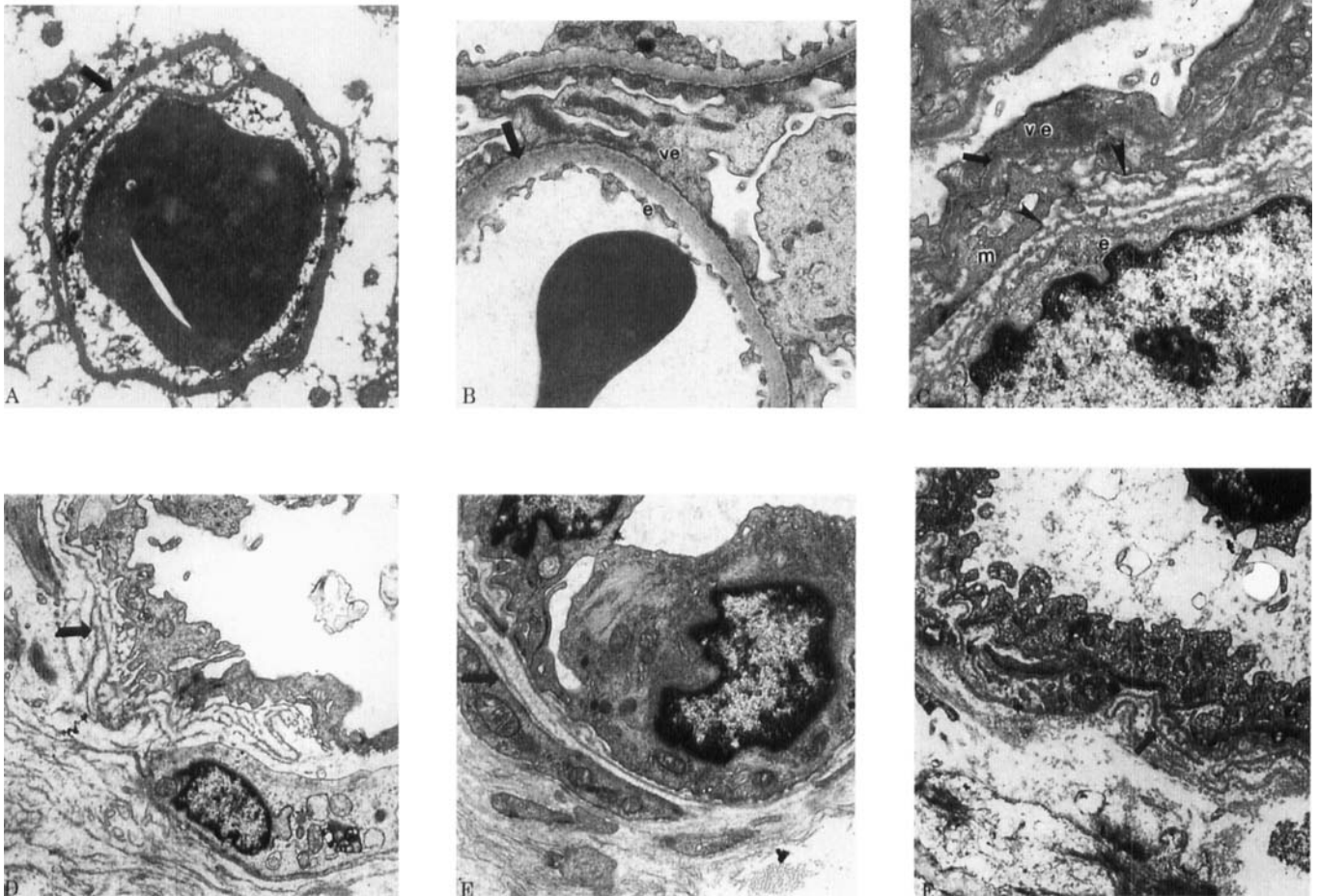

*Figure 4. Brain MRIs of patient III-2. (A) Neurologically asymptomatic except for migraine-like headache with onset of retinopathy at age 31, multiple small subcortical hyperintense lesions on T2-weighted images. (B) Slight clumsiness in her left hand and left leg at age 36, contrast-enhancing lesions with surrounding edema in the right frontoparietal subcortical region on T1-weighted images. (C) Persistent headache with an episode of projectile vomiting but no other neurologic changes, increased size of the lesions with marked edema and mass effect on proton-weighted images. (D) After 3 days of intravenous Decadron, decreased edema on proton-weighted images.*

Renal specimen by light microscopy displayed irregularly thickened capillary walls and slightly widened mesangial regions. By electron microscopy, most glomerular capillary

walls were thickened, often with peripheral migration and interposition of mesangial cells. The original (subepithelial) basement membranes were normal; however, subendothelial





**Figure 5.** Electron microscopic appearance of vessels. (A) Brain, patient III-3. Reprocessed specimen with several layers of basement membrane (arrow) in cerebral capillary ( $\times 11,000$ , before 32% reduction). (B) Normal glomerular capillary wall from age-matched control to patient III-2. Note uniform appearance and thickness of basement membrane (arrow) (ve = visceral epithelial cell, e = endothelial cell) ( $\times 10,000$ , before 32% reduction). (C) Glomerular capillary wall, patient III-2. The original basement membrane (arrow) beneath visceral epithelial cell (ve), while somewhat wrinkled, approaches a normal appearance. The basement membrane (arrowheads) beneath endothelial cell (e) is multilayered. A mesangial cell (m) separates the two basement membranes ( $\times 12,800$ , before 30% reduction). (D) Renal peritubular capillary (patient III-2) with multilayered basement membrane (arrow) beneath endothelial cell ( $\times 10,000$ , before 32% reduction). (E) Cutaneous vessel (patient III-2) with similar multilayered basement membrane changes (arrow) ( $\times 11,400$ , before 32% reduction). (F) Gastric mucosa (patient III-9) with multilayered capillary basement membrane (arrow) ( $\times 9,900$ , before 30% reduction).

basement membranes were multilayered with alternating medium dense and lucent zones (figure 5, B and C). Endothelial cell cytoplasm was normal or slightly swollen. Similar changes were noted in glomerular capillary walls without mesangial interposition. Basement membranes of peritubular capillaries and beneath arterial and arteriolar endothelial cells were also multilayered with an appearance identical to that described for glomerular capillaries (figure 5D). Tubular basement membranes had a normal appearance or were irregularly thickened in atrophic structures.

Ultrastructural examination of appendix, omentum, and skin (figure 5E) of patient III-2 and gastric tissue from III-9 (figure 5F) disclosed multilayered basement membranes, similar to the above, beneath endothelial cells of capillaries, arterioles, and venules.

There was no evidence of either abnormal mitochondria or accumulation of mitochondria in any tissue examined by electron microscopy.

**Genetic studies.** Linkage analysis was performed to determine whether the vasculopathy in this kindred was linked to the CADASIL locus. The pairwise linkage data, with the assumption that the disease is caused by a single defective gene with dominant inheritance, are given in table 2. At a recombination fraction of 0.0 all of the markers had a lod score of  $-3$  or less. For marker D19S841, reported to have the highest combined lod score in families with CADASIL,<sup>12</sup> the lod score in our family was negative at a recombination fraction of 0.05. This linkage data makes it extremely unlikely that the *Notch3* mutation on 19p causing CADASIL is involved in the pathogenesis of hereditary endotheliopathy with retinopathy, nephropathy, and stroke (HERNS) in this kindred.

**Discussion.** We report a syndrome of retinopathy, nephropathy, and recurrent strokes with a hereditary

**Table 2** Results of pairwise linkage analyses of chromosome 19

Marker	lod score at $\theta =$						
	0	0.01	0.05	0.1	0.2	0.3	0.4
D19S413	-4.53622	-0.854223	-0.223966	-0.01026	0.113139	0.111679	0.065115
D19S221	-2.9999	0.182049	0.83045	1.023206	1.013965	0.793097	0.449216
D19S226	-3.77144	0.181826	0.830424	1.023194	1.013962	0.793096	0.449216
D19S841	-5.74242	-1.558315	-0.715162	-0.339933	-0.045479	0.0248	0.013328
D19S253	-5.175697	-1.604074	-0.739067	-0.347303	-0.040075	0.02997	0.014812

pattern most consistent with autosomal dominant inheritance. The underlying mechanism appears to be a generalized vasculopathy with disruption of the integrity of capillaries and arterioles. Fluorescein angiograms clearly demonstrate retinal vasculopathic changes. That the intracerebral lesions showed contrast enhancement on imaging studies indicates breakdown of the blood-brain barrier. The surrounding edema in a vasogenic pattern also suggests increased capillary permeability. Furthermore, findings from renal, skin, and gastric biopsy specimens demonstrate systemic basement membrane abnormalities. Since basement membrane is synthesized by the endothelial cells, the basement membrane abnormalities may reflect primary endothelial injury.

The radiologic findings of contrast-enhancing, space-occupying lesions in the frontoparietal region and the clinical profile of cerebral and retinal involvement in patients of this kindred are similar to those reported in hereditary cerebrotretinal vasculopathy, which is of autosomal dominant inheritance.<sup>4,5</sup> However, renal insufficiency seen in this kindred is not a feature in the latter entity. It is unclear whether HERNS is the same as cerebrotretinal vasculopathy,<sup>4,5</sup> where only limited light microscopic findings are available and no systemic involvement has been documented. Electron microscopic examination of the biopsy specimens from affected members of other pedigrees may help clarify whether the vasculopathic features in these families are similar.

Although pedigree in this kindred raises the possibility of maternal transmission, the pathologic findings in HERNS are not consistent with a mitochondrial disorder. Multifocal cortical and subcortical lesions in patients with mitochondrial myopathy, encephalopathy, lactic acidosis, and stroke-like episodes (MELAS) are thought to result from mitochondrial angiopathy, characterized by accumulations of abnormal mitochondria in vascular smooth muscle and endothelial cells.<sup>13</sup> In this kindred, we observed no abnormal mitochondria or accumulation of these organelles in tissues processed for ultrastructural studies. Furthermore, multilaminated basement membrane, a prominent finding in HERNS, has not been reported in mitochondrial angiopathy. The microangiopathy in HERNS is unlikely to result from mitochondrial abnormality.

This kindred has a vasculopathic process distinct from CADASIL. Pathologically, CADASIL is charac-

terized mainly by normal endothelial cells and basal lamina but concentrically thickened media of cerebral microvessels, which on ultrastructural examination shows an electron dense granular material interspersed among the smooth muscle layer extending into the adventitia.<sup>14,15</sup> HERNS is characterized by a microangiopathy with markedly thickened, multilayered subendothelial basement membranes. Further evidence for the distinction between HERNS and CADASIL is the absence of linkage to the CADASIL locus on chromosome 19. Locus heterogeneity in hereditary multi-infarct dementia has been reported by others.<sup>16</sup>

Progressive neuropsychiatric deterioration is common to Binswanger subcortical leukoencephalopathy (BSL), CADASIL, hereditary cerebrotretinal vasculopathy, and HERNS (table 3). These symptoms and signs are most likely manifestations of diffuse CNS damage brought about by multifactorial mechanisms.<sup>17</sup> Similarly, migraine-like headache, another common feature, may reflect vasculopathy without regard to specific pathogenesis.

The clinical significance and the pathologic basis of white matter signal changes remain poorly understood. Breakdown of the blood-brain barrier resulting in increased vascular permeability appears to be the common final pathway in all the multi-infarct syndromes. Endothelial injury brings about major biochemical changes: increased oxygen free radical formation; increased production of endothelial, smooth-muscle cell, and astrocytic mitogens as well as chemotactic factors for neutrophils and fibroblasts; release of vasoactive compounds such as histamine and endothelin; decreased prostacyclin; and decreased plasminogen activator activity.<sup>18,19</sup> These biochemical changes may lead to endothelial proliferation, perivascular inflammation, astrocyte and smooth muscle cell proliferation, thrombus formation, and vasoconstriction. Increased filter permeability and focal brain edema contribute to cerebral tissue injury.

Endothelial injury is common to many disorders, including hypertension, thrombotic microangiopathies, diabetes mellitus, immunologically mediated injury, metabolic damage, and, probably, Alzheimer's disease.<sup>20,21</sup> In the more common disorders with morphologic abnormalities of capillary basement membranes such as diabetes mellitus, glomerular capillaries typically show uniform thickening of



**Table 3** Comparison of leukoencephalopathic syndromes

Syndrome	Heredity	Clinical features	Radiographic features	Vasculopathic features
Binswanger subcortical leukoencephalopathy (BSL)	Sporadic	Strokes, mood disorders, dementia	Non-contrast-enhancing white matter high T2 signal lesions	Thickened, hyalinized arterioles
Mitochondrial myopathy, encephalopathy, lactic acidosis, stroke-like episodes (MELAS)	Maternal transmission	Seizures, alternating hemiparesis	Multifocal gray and white matter high T2 signal lesions	Mitochondrial angiopathy with accumulation of abnormal mitochondria in swollen cerebral capillary endothelial cells and arteriolar smooth muscle cells
CADASIL	Autosomal dominant	Strokes, migraine, mood disorders, dementia	Non-contrast-enhancing white matter high T2 signal lesions	Systemic non-atheromatous, non-amyloid arteriopathy with destruction of the vascular smooth muscle cells and the formation of granular, electron-dense, eosinophilic material
Hereditary cerebretinal vasculopathy	Autosomal dominant	Strokes, retinopathy, dementia	Contrast-enhancing white matter lesions with vasogenic edema	Fibrinoid necrosis without inflammation†
*Hereditary endotheliopathy with retinopathy, nephropathy, and stroke (HERNS)	Autosomal dominant	Strokes, retinopathy, nephropathy, migraine, mood disorders, dementia	Contrast-enhancing white matter lesions with vasogenic edema	Systemic vasculopathic changes with multilaminated basement membrane

\* This report.

† Light microscopy only.

basement membrane.<sup>20</sup> Galloway-Mowat syndrome, a rare inherited disorder of microcephaly, nephrotic syndrome, and hiatal hernia,<sup>22</sup> is characterized by thickened but structurally disorganized glomerular basement membrane with normal endothelial cells and basement membranes in non-renal tissues.<sup>23</sup> None of these disorders exhibit the characteristic multilayering of basement membrane seen in the kindred we describe. It should be noted, however, that multilayering of peritubular capillary basement membranes is common in chronic renal transplant rejection and has been considered a manifestation of recurrent endothelial cell injury in this setting.

It is unclear why a generalized vasculopathy should preferentially affect the brain, the retina, and the kidney. One explanation may be that these organs rely heavily on an intact endothelial barrier to maintain proper function and are particularly "eloquent" when injured. Furthermore, the basis for the regional vulnerability in the brain is intriguing in that the intracranial mass lesions tended to involve the frontoparietal region in both HERNS and cerebretinal vasculopathy.

It is also puzzling that, although focal edema was noted in brain tissues from the various syndromes, white matter lesions on neuroradiologic studies of BSL and CADASIL do not show contrast enhancement, whereas those in hereditary cerebretinal vasculopathy and in HERNS do. Differences in the types of vessels affected and chronicity may account for the discrepancy we observe in these various

multi-infarct syndromes. One possible explanation is that the vasculopathy in BSL and CADASIL involves mainly arterioles, whereas the smaller vessels are affected in hereditary cerebretinal vasculopathy and HERNS. The progression of disease is much more rapid in the latter conditions, making it more difficult for the brain to compensate for markedly increased edema.

There is no effective treatment to offer patients with HERNS. Aspirin, with its antiplatelet actions, has not shown any benefit in several patients in this family. Resection of the "pseudotumor" has not helped those who underwent this procedure, nor has laser treatment been shown to control retinal vasculopathy. Other than supportive care (e.g., physical therapy, corticosteroid to minimize cerebral edema, and antihypertensive medication for renal disease-induced hypertension), treatment would ideally be aimed at maintaining the integrity of the capillaries as well as prevention of the progression of white matter damage. Grand et al.<sup>4</sup> noted the histologic similarities between hereditary cerebretinal vasculopathy and delayed radiation-induced cerebral necrosis. Delayed cerebral radiation necrosis appears to result from damage of the endothelial cells of small vessels.<sup>24</sup> The observation of similarities between hereditary cerebretinal vasculopathy and delayed radiation-induced cerebral necrosis may have important therapeutic implications since anti-coagulation may arrest and reverse endothelial injury and has been shown to produce clinical im-

provement in some patients with the latter condition.<sup>25</sup>

In addition to CADASIL and HERNs, we anticipate recognition of other forms of hereditary vasculopathy with systemic involvement. In patients with familial multi-infarct syndrome, skin biopsy with careful ultrastructural examination may provide much needed pathologic details.

## References

1. Sourander P, Wälinder J. Hereditary multi-infarct dementia. *Acta Neuropathol (Berl)* 1977;39:247-254.
2. Tournier-Lasserre E, Iba-Zizen M-T, Romero N, Bousser M-G. Autosomal dominant syndrome with stroke-like episodes and leukoencephalopathy. *Stroke* 1991;22:1297-1302.
3. Joutel A, Corpechot C, Ducros A, et al. *Notch3* mutations in CADASIL, a hereditary adult-onset condition causing stroke and dementia. *Nature* 1996;383:707-710.
4. Grand MG, Kaine J, Fulling K, et al. Cerebroretinal vasculopathy. *Ophthalmology* 1988;95:649-659.
5. Gutmann DH, Fischbeck KH, Sergott RC. Hereditary retinal vasculopathy with cerebral white matter lesions. *Am J Med Genet* 1989;34:217-220.
6. Chien K, van de Velde RL, Heusser RC. A one-step method for re-embedding paraffin embedded specimens for electron microscopy. In: Bailey GW, ed. *Proceedings of the fortieth annual meeting of the Electron Microscopy Society of America*, Baton Rouge: Claitor's Pub Div, 1982:356-357.
7. Cohen AH, Border WA, Rajfer J, Dumke A, Glasscock RJ. Interstitial Tamm-Horsfall protein in rejecting renal allografts: identification and morphologic pattern of injury. *Lab Invest* 1984;50:519-525.
8. Bell GI, Karam JH, Rutter WJ. Polymorphic DNA region adjacent to the 5' end of the human insulin gene. *Proc Natl Acad Sci USA* 1981;78:5759-5763.
9. Litt M, Hauge XY, Sharma V. Shadow bands seen when typing polymorphic dinucleotide repeats: some causes and cures. *Biotechniques* 1993;15:280-284.
10. Gyapay G, Morissette J, Vignal A, et al. The 1993-94 Génethon human genetic linkage map. *Nat Genet* 1994;7:246-339.
11. Schaffer AA, Gupta SK, Shriram K, Cottingham RW. Avoiding recomputation in linkage analysis. *Hum Hered* 1994;44:225-237.
12. Ducros A, Nagy T, Alamowitch S, et al. Cerebral autosomal dominant arteriopathy with subcortical infarcts and leukoencephalopathy, genetic homogeneity, and mapping of the locus within a 2-cM interval. *Am J Hum Genet* 1996;58:171-181.
13. Ohama E, Ohara S, Ikuta F, et al. Mitochondrial angiopathy in cerebral blood vessels of mitochondrial encephalomyopathy. *Acta Neuropathol (Berl)* 1987;74:226-233.
14. Baudrimont M, Dubas F, Joutel A, Tournier-Lasserre E, Bousser M-G. Autosomal dominant leukoencephalopathy and subcortical ischemic stroke. *Stroke* 1993;24:122-125.
15. Ruchoux M-M, Guerouaou D, Vandenhoute B, Pruvo J-P, Vermersch P, Leys D. Systemic vascular smooth muscle cell impairment in cerebral autosomal dominant arteriopathy with subcortical infarcts and leukoencephalopathy. *Acta Neuropathol (Berl)* 1995;89:500-512.
16. St. Clair D, Bolt J, Morris S, Doyle D. Hereditary multi-infarct dementia unlinked to chromosome 19q12 in a large Scottish pedigree: evidence of probable locus heterogeneity. *J Med Genet* 1995;32:57-60.
17. Salloway S, Cummings J. Subcortical disease and neuropsychiatric illness. *J Neuropsychiatry Clin Neurosci* 1994;6:93-99.
18. Baker DG, Krochak RJ. The response of the microvascular system to radiation: a review. *Cancer Invest* 1989;7:287-294.
19. Eldor A, Fuks Z, Matzner Y, Witte LD, Vlodavsky I. Perturbation of endothelial functions by ionizing irradiation: effects on prostaglandins, chemoattractants and mitogens. *Semin Thromb Hemost* 1989;15:215-225.
20. Cotran RS, Kumar V, Robbins SL, eds. *Robbins pathologic basis of disease*. 5th ed. Philadelphia: Saunders, 1994.
21. Stewart PA, Hayakawa K, Akers M-A, Vinters HV. A morphometric study of the blood-brain barrier in Alzheimer's disease. *Lab Invest* 1992;67:734-742.
22. Galloway WH, Mowat AP. Congenital microcephaly with hiatus hernia and nephrotic syndrome in two siblings. *J Med Genet* 1968;5:319-321.
23. Cohen AH, Turner MC. Kidney in Galloway-Mowat syndrome: clinical spectrum with description of pathology. *Kidney Int* 1994;45:1407-1415.
24. Rottenberg DA, Chernik NL, Deck MDF, Ellis F, Posner JB. Cerebral necrosis following radiotherapy of extracranial neoplasms. *Ann Neurol* 1977;1:339-357.
25. Glantz MJ, Burger PC, Friedman AH, Radtke RA, Massey EW, Schold SC. Treatment of radiation-induced nervous system injury with heparin and warfarin. *Neurology* 1994;44:2020-2027.

**Hereditary endotheliopathy with retinopathy, nephropathy, and stroke(HERNS)**

J. Jen, A. H. Cohen, Q. Yue, et al.  
*Neurology* 1997;49;1322-1330  
DOI 10.1212/WNL.49.5.1322

**This information is current as of November 1, 1997**

<b>Updated Information &amp; Services</b>	including high resolution figures, can be found at: <a href="http://www.neurology.org/content/49/5/1322.full.html">http://www.neurology.org/content/49/5/1322.full.html</a>
<b>References</b>	This article cites 23 articles, 2 of which you can access for free at: <a href="http://www.neurology.org/content/49/5/1322.full.html##ref-list-1">http://www.neurology.org/content/49/5/1322.full.html##ref-list-1</a>
<b>Citations</b>	This article has been cited by 19 HighWire-hosted articles: <a href="http://www.neurology.org/content/49/5/1322.full.html##otherarticles">http://www.neurology.org/content/49/5/1322.full.html##otherarticles</a>
<b>Permissions &amp; Licensing</b>	Information about reproducing this article in parts (figures, tables) or in its entirety can be found online at: <a href="http://www.neurology.org/misc/about.xhtml#permissions">http://www.neurology.org/misc/about.xhtml#permissions</a>
<b>Reprints</b>	Information about ordering reprints can be found online: <a href="http://www.neurology.org/misc/addir.xhtml#reprintsus">http://www.neurology.org/misc/addir.xhtml#reprintsus</a>

